

All-in-One Android Video Collaboration Bar for Small and Huddle Room

Yealink MeetingBar A20 Teams Edition, an all-in-one video collaboration bar for small and huddle rooms. Featuring 20MP camera and 133 ° super-wide-angle lens, A20 delivers outstanding video quality. Together with the electric lens cap, its AI technologies including auto framing and speaker tracking and so on allow users to experience a smarter and safer video conference. With 8 MEMS microphone arrays and Yealink noise proof algorithm, A20 brings excellent audio experience in small rooms even in full-duplex mode and ensures that everyone can be heard as well as seen. Supporting human body detection, A20 provides convenient and fast meeting experience. Moreover, A20 combines codec, camera, microphone, speaker, Wi-Fi, and Bluetooth, which provides you a solution of simple deployment. Cooperating with Teams client, A20 is capable of content sharing and whiteboard that making the meeting more communicative and collaborative. Simple and flexible deployment but powerful features together with available price deliver excellent video collaboration performance.



Android 9.0 OS



20MP Camera



Wide-angle Lens



Auto Privacy Shutter



Microphone Array



Built-in Speaker



Dual Screen Display



Auto Framing



Speaker Tracking



Wi-Fi & Bluetooth



Key Features and Benefits

Smart Video Collaboration

Based on Android OS and the video collaboration serviced by Microsoft Teams Room Cloud, A20 owns a TV-styled interactive user interface that all features can be operated by just one touch or by the remote controller. Meanwhile, when A20 works together with Teams Client, both content sharing and whiteboard are within your reach.

See Everyone Clearly

20 MP camera brings clear and smooth video conference with delicate details video conference with delicate details. With super-wide 133° field of view, everyone in the conference can be seen without adjusting the camera. Moreover, the image brightness can be automatically optimized even in a dim or backlight environment, ensuring the participant faces can be seen clearly.

Smart Video Conferencing with AI Technology

Featuring AI technology, including Auto Framing and Speaker Tracking, A20 not only supports framing the groups automatically according to the number and the position of the participants, but also automatically zoom in the speaker without adjusting the camera, making the participants more focus on the conference.









Precise Sound Localization, Full-Duplex Experience

8 MEMS microphone arrays make A20 have stronger ability of noise proof and dereverberation. The new upgraded beamforming algorithm, together with technology of processing on acoustic echo cancellation and the dereverberation, brings high quality full-duplex call and pick up more accurate voice.

Compact Design for Fast Start

Integrating Android OS, codec, camera, microphones, speaker, Bluetooth, Wi-Fi and bracket, A20 takes up less space and minimizing cable clutter. For your easy deployment, it is ready for a video conference by simply plugging in the PoE supply and HDMI cable. In addition, the Teams admin center portal ensures an easy management to you.

- All-in-one design
- Android 9.0 OS
- 133° wide-angle lens
- Electric lens cap
- Auto framing and speaker tracking
- Dedicated HD audio
- Built-in Bluetooth
- Built-in dual-band Wi-Fi
- Content sharing
- Whiteboard

<p>Camera</p> <ul style="list-style-type: none"> • 20MP Camera • 133° field of view • 4x e-PTZ camera • Auto Privacy Shutter • Intelligence Feature <ul style="list-style-type: none"> - Auto Framing - Speaker Tracking 	<ul style="list-style-type: none"> - Camera On/Off - Mute/Unmute - Volume Up/Down - Hang up <p>Video Standard and Network Suitability</p> <ul style="list-style-type: none"> • Video codecs: H.264 High profile, H.264, SVC-T • Anti video packet loss • Bandwidth dynamic adaptive adjustment 	<ul style="list-style-type: none"> • 1 x Power port • 1 x Security lock slot • 1 x Reset slot <p>Other Physical Features</p> <ul style="list-style-type: none"> • Storage: built-in 64 GB (Available:40G) • Yealink PoE Adapter: AC 100~240V input • USB Output: 5V \equiv 0.5A • Power consumption (PSU): <ul style="list-style-type: none"> Idle 10W; Normal operating: 10.5W; MAX: 14W • Dimension (W.D.H): 600 mm x 68 mm x 82 mm • Operating humidity: 10~95% • Operating temperature: 0~40°C • Storage temperature: -30~70°C
<p>Audio</p> <ul style="list-style-type: none"> • Built-in 8 MEMS microphone array • Support extension mic • Built-in 5W high fidelity speaker • Yealink Noise Proof Technology • Beamforming directed voice pickup technology • Full-duplex • Echo cancellation 	<p>Network and Security Features</p> <ul style="list-style-type: none"> • Built-in dual-band Wi-Fi (2.4GHz/5GHz) • Built-in Bluetooth • IPv4 and IPv6, DHCP/static IP • HTTP/HTTPS web server • SRTP/TLS, AES 256-bit encryption • QoS: 802.1p/q, Diff-serv • VLAN, LLDP • IEEE802.1X <ul style="list-style-type: none"> - EAP-MD5/EAP-TLS - PEAP-MSCHAPv2 - EAP-TTLS/EAP-MSCHAPv2 • Network diagnosis: Ping, Trace route • Time and date synchronization using SNTP • Built-in certificate 	<p>A20-Teams Package</p> <ul style="list-style-type: none"> • Package contents: <ul style="list-style-type: none"> - MeetingBar A20 - 3m Network cable - 1.8m HDMI cable - Power adapter - Quick Start Guide • Carton Meas :674*136*195mm
<p>Operating System</p> <ul style="list-style-type: none"> • Based on Android 9.0 		
<p>Meeting Features</p> <ul style="list-style-type: none"> • Calendar • One-click join • Proximity join • PSTN dial-in • Meeting collaboration <ul style="list-style-type: none"> - Content sharing - Whiteboard • Meeting control: <ul style="list-style-type: none"> - Add participates - Hold/Resume 	<p>A20 Connection</p> <ul style="list-style-type: none"> • 2 x HDMI output (CEC supported) • 2 x USB 2.0 • 1 x 10/100M/1000M Ethernet port • 1 x Yealink extension port (RJ-45) 	<p>Compliance</p> <p>      </p> <p>    </p>

Endpoint Connections

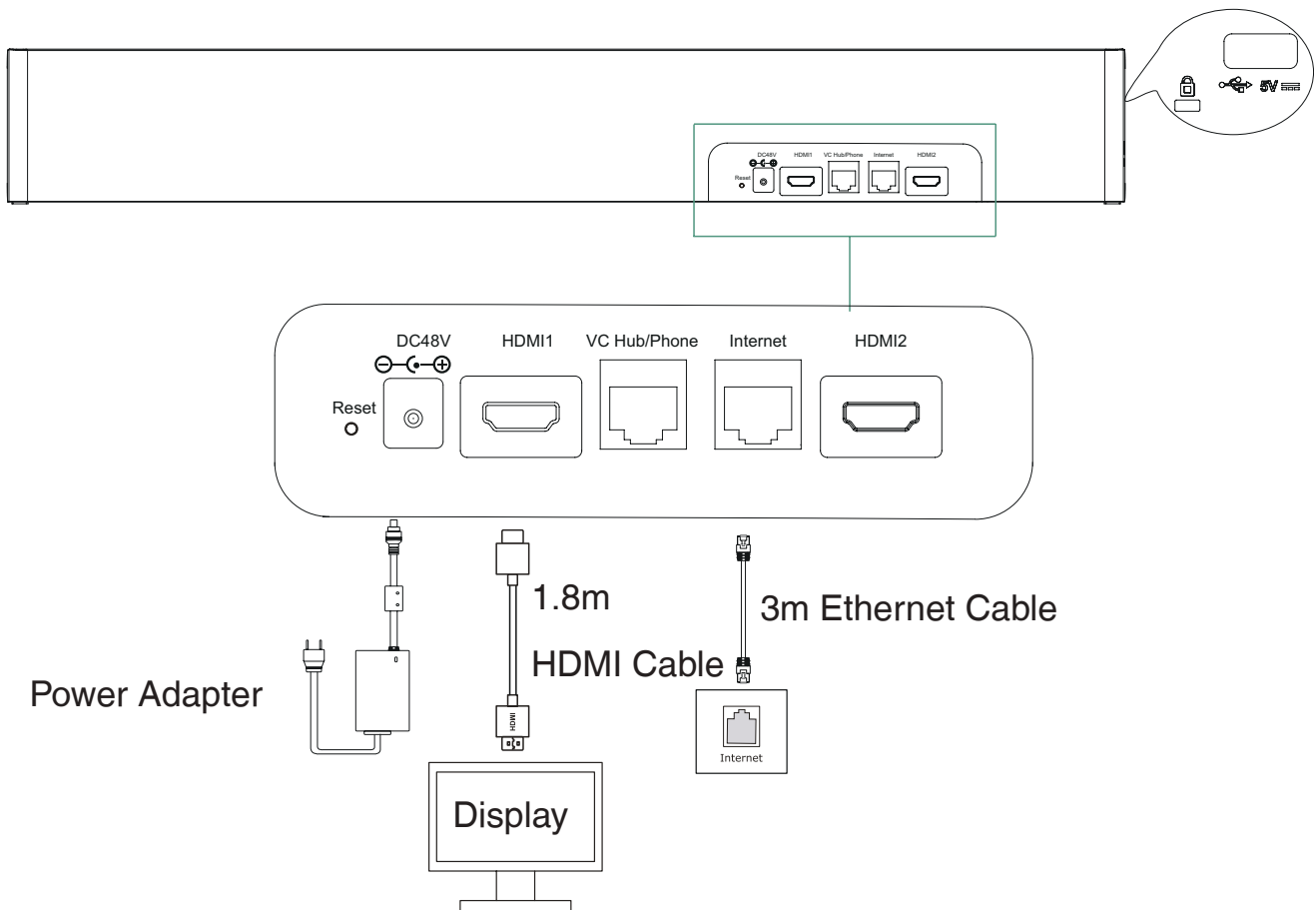

Note:

- If you connect a touch display device, you can operate the A20 either by remote control or touch control.
- If you connect a non-touch display device, you can only use the remote control.

About Yealink

Yealink is a global leading provider of enterprise communication and collaboration solutions, offering video conferencing service to worldwide enterprises. Focusing on research and development, Yealink also insists on innovation and creation. With the outstanding technical patents of cloud computing, audio, video and image processing technology, Yealink has built up a panoramic collaboration solution of audio and video conferencing by merging its cloud services with a series of endpoints products. As one of the best providers in more than 140 countries and regions including the US, the UK and Australia, Yealink ranks No.1 in the global market share of SIP phone shipments.

Copyright

Copyright © 2020 YEALINK(XIAMEN) NETWORK TECHNOLOGY CO., LTD.

Copyright © 2020 Yealink(Xiamen) Network Technology CO., LTD. All rights reserved. No parts of this publication may be reproduced or transmitted in any form or by any means, electronic or mechanical, photocopying, recording, or otherwise, for any purpose, without the express written permission of Yealink(Xiamen) Network Technology CO., LTD.

Technical Support

Visit Yealink WIKI (<http://support.yealink.com/>) for firmware downloads, product documents, FAQ, and more. For better service, we sincerely recommend you to use Yealink Ticketing system (<https://ticket.yealink.com>) to submit all your technical issues.



YEALINK(XIAMEN) NETWORK TECHNOLOGY CO.,LTD.
Web: www.yealink.com
Addr: No.1 Ling-Xia North Road, High Tech Park,
Huli District, Xiamen, Fujian, P.R.C
Copyright©2020 Yealink Inc. All right reserved.